

PIN FACE FRONT VIEW

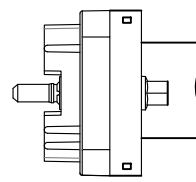

WHITE/BLACK
GREEN/YELLOW

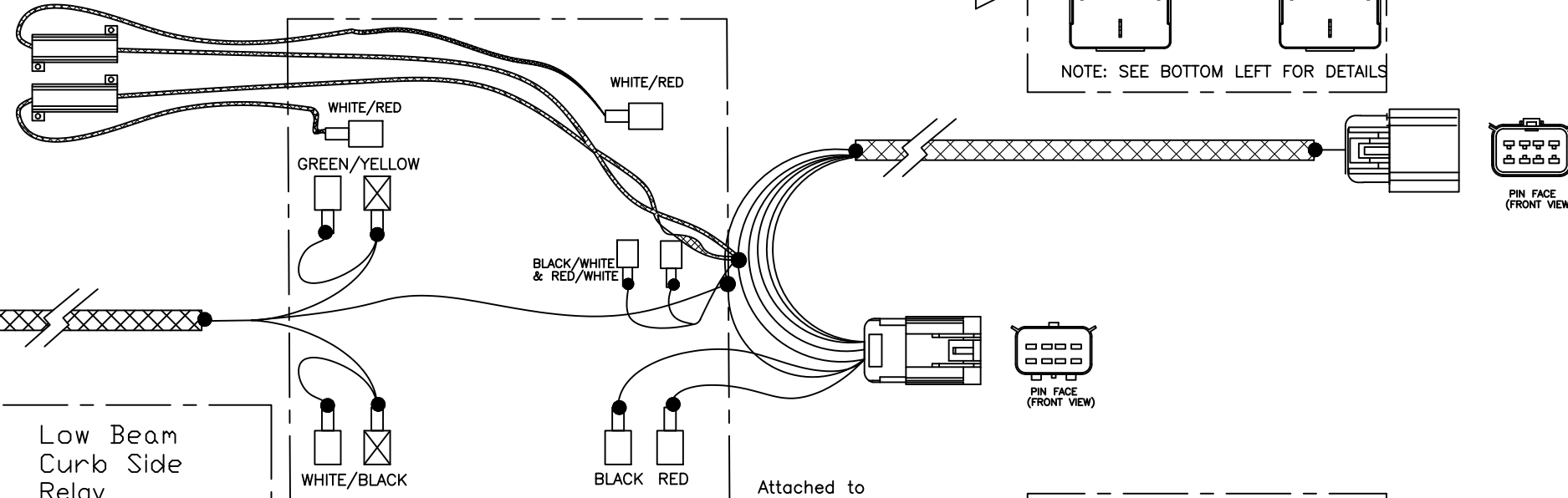
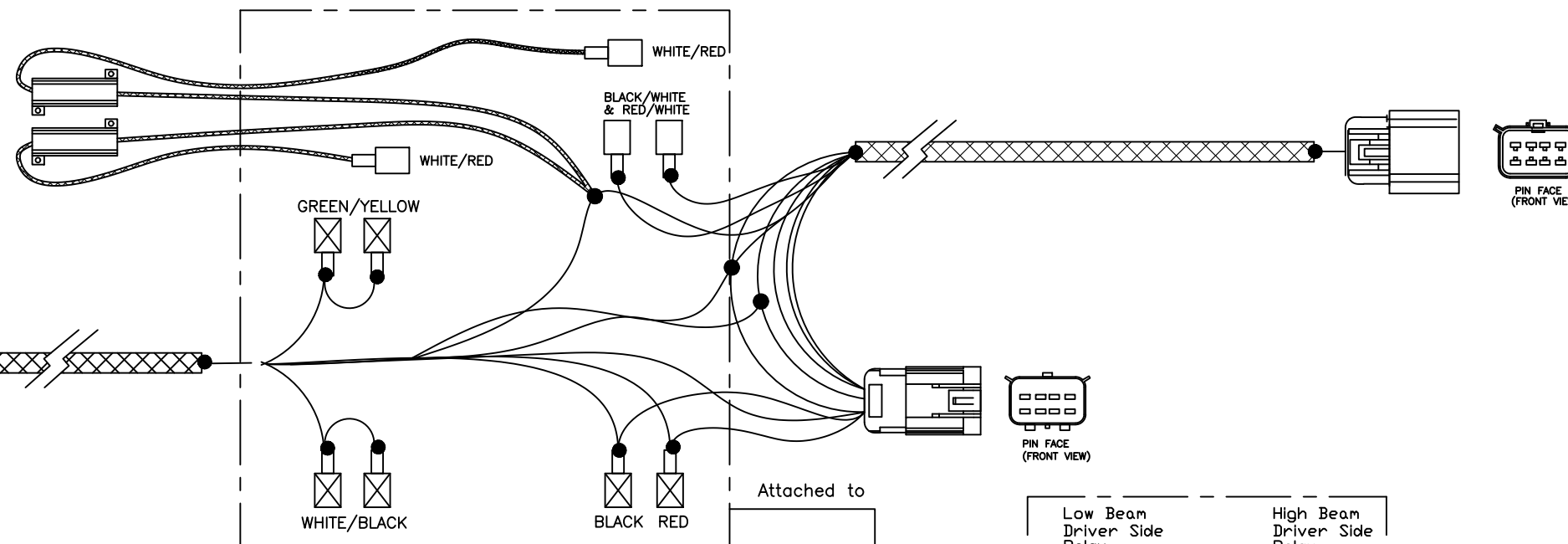

High Beam Drivers Side Relay

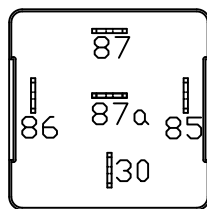

Low Beam Drivers Side Relay

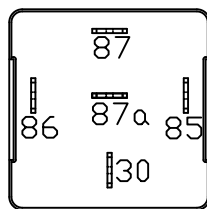

High Beam Curb Side Relay

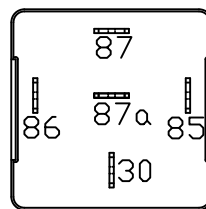

Low Beam Curb Side Relay

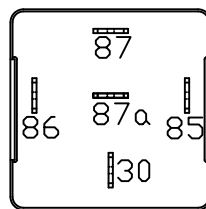

HIGH	
PIN #	COLOR
85	GREEN/YELLOW
86	WHITE/BLACK
30	YELLOW/RED (DBL)
87	WHITE/RED (R1 or R2)
87a	YELLOW

LOW	
PIN #	COLOR
85	GREEN/YELLOW
86	WHITE/BLACK
30	GREEN/RED (DBL)
87	WHITE/RED (R1 or R2)
87a	Lt. GREEN

LOW	
PIN #	COLOR
85	GREEN/YELLOW
86	WHITE/BLACK
30	YELLOW/RED#1
87	WHITE/RED#1(R3 or R4)
87a	YELLOW#1

HIGH	
PIN #	COLOR
85	GREEN/YELLOW
86	WHITE/BLACK
30	GREEN/RED#1
87	WHITE/RED#1(R3 or R4)
87a	Lt. GREEN#1